











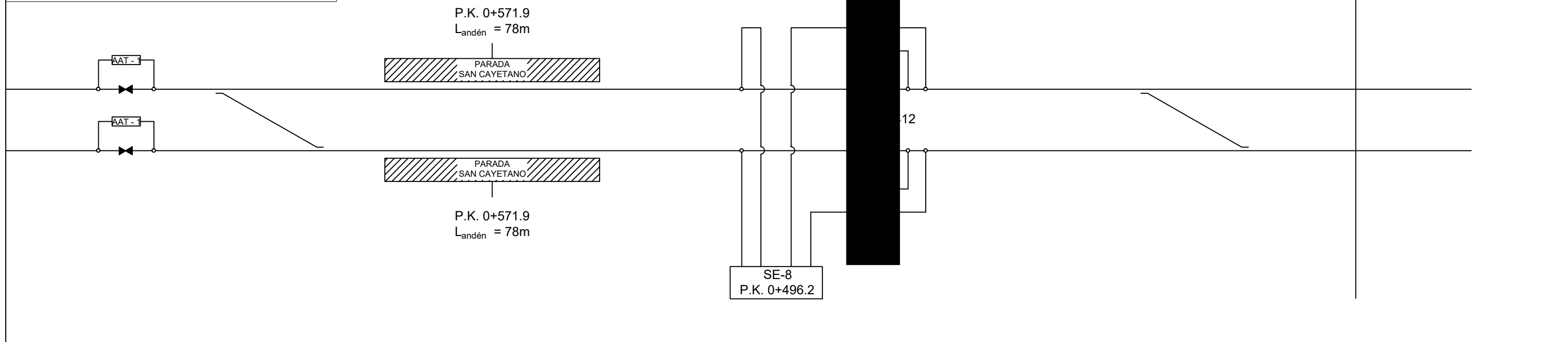

LEYENDA

- Aislador de sección 
- Seccionador de puesta a tierra 
- A.A.T 
- A.F 
- Subestaciones 
- Paradas 



LEYENDA

- Aislador de sección 
- Seccionador de puesta a tierra 
- A.A.T 
- A.F 
- Subestaciones 
- Paradas 

P.K. 2+700.0

INICIO TRAMO CHURRIANA DE LA VEGA - LAS GABIAS FIN TRAMO ARMILLA - CHURRIANA DE LA VEGA

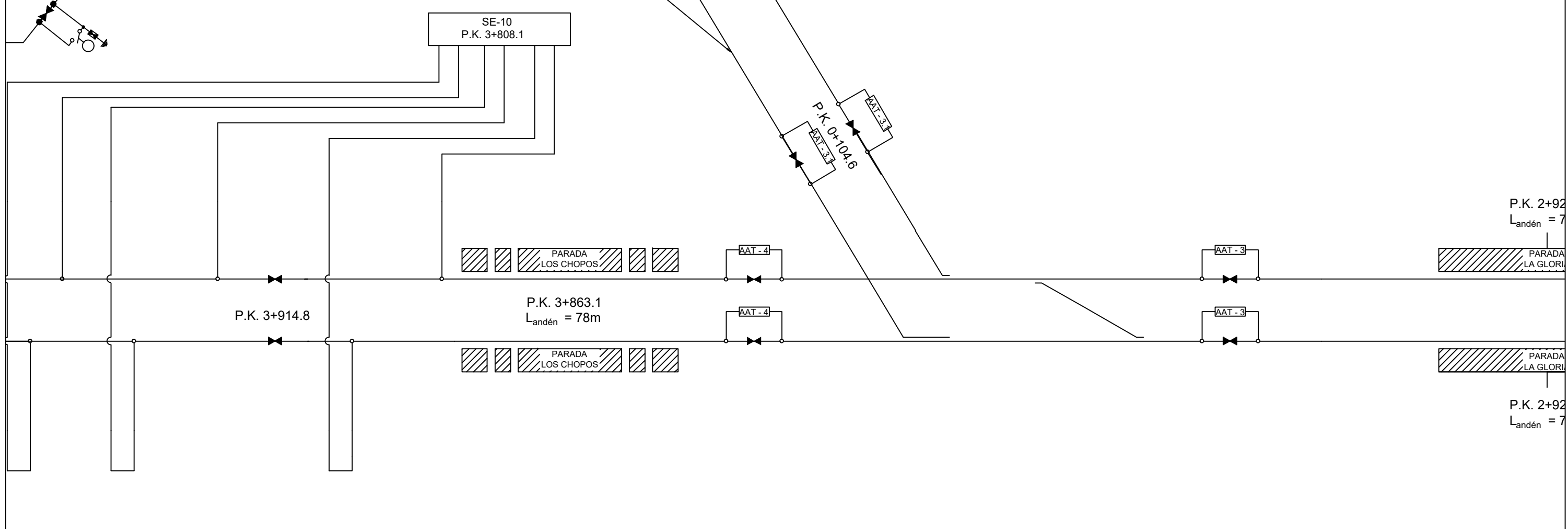
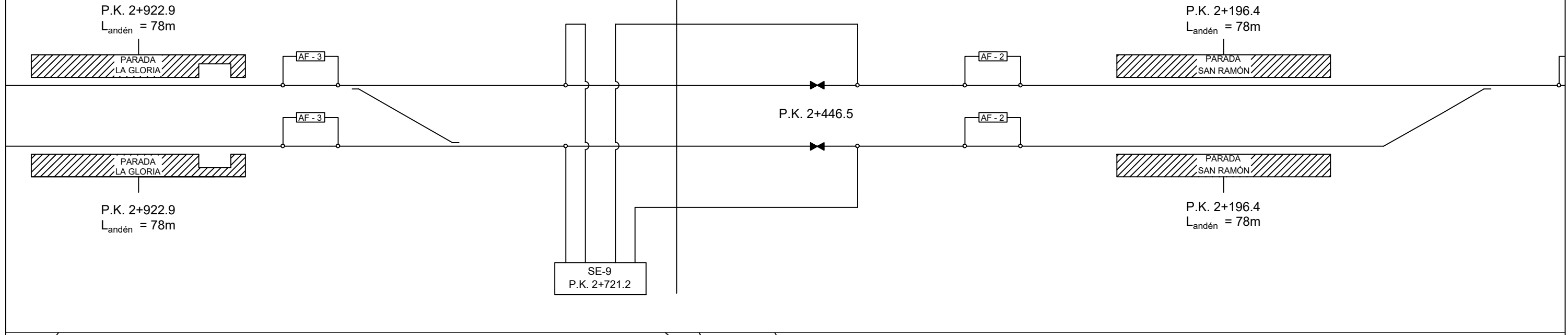

P.K. 4+769

FIN
TRAMO CHURRIANA DE LA VEGA -
LAS GABIAS

P.K. 4+728.75
L_{andén} = 79m

PARADA
LAS GABIAS

AF-4

PARADA
LAS GABIAS

P.K. 4+728.75
L_{andén} = 79m

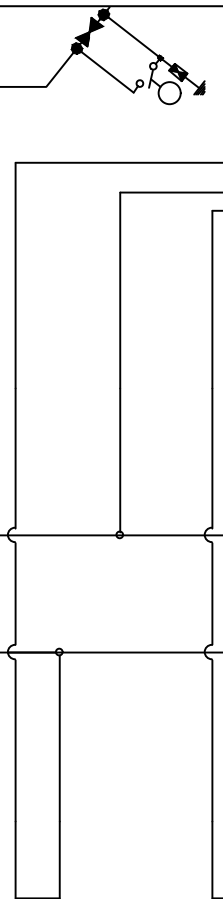

LEYENDA

Aislador de sección	
Seccionador de puesta a tierra	
A.A.T	
A.F	
Subestaciones	
Paradas	

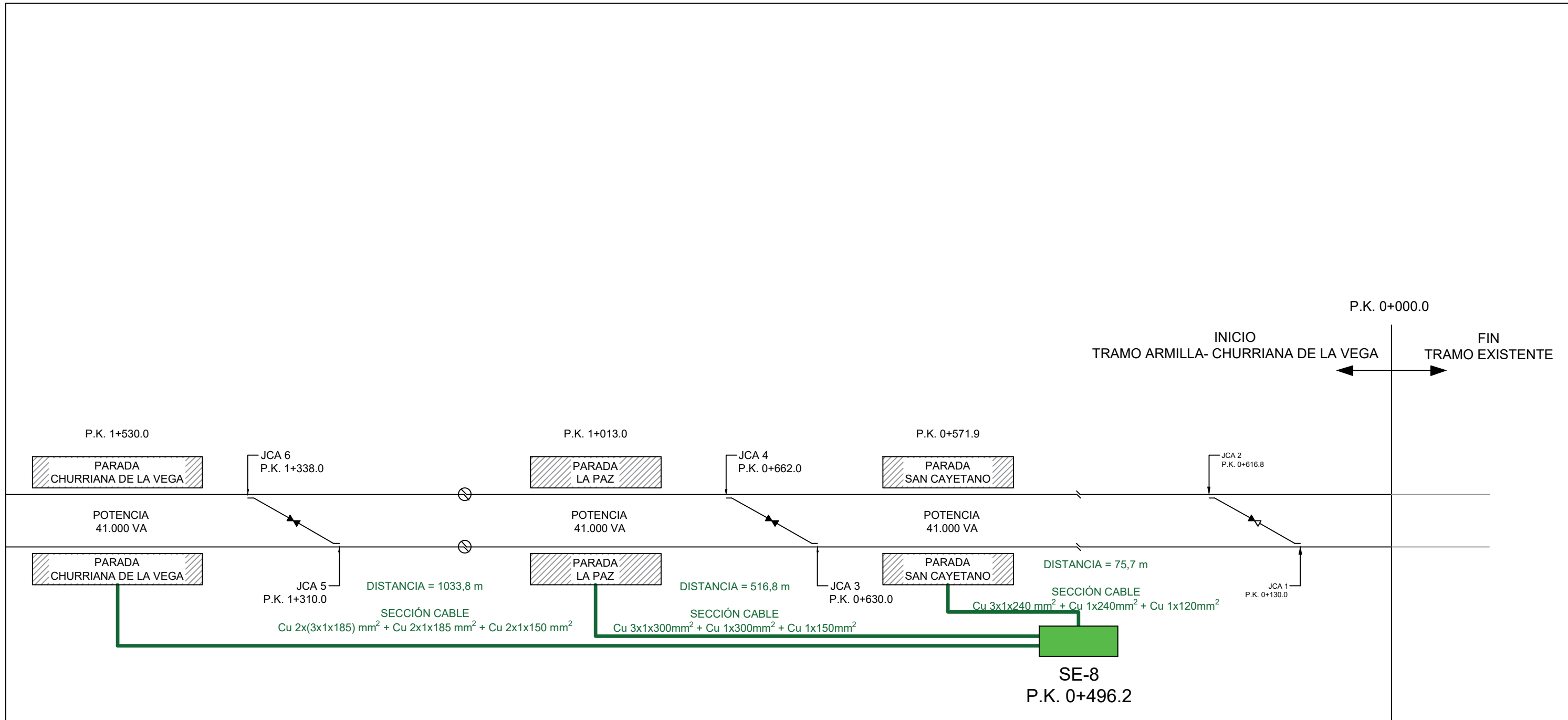

LEYENDA	
Aislador de sección	
Seccionamiento de lámina de aire	
Seccionamiento mecánico	
Subestaciones	
Paradas	

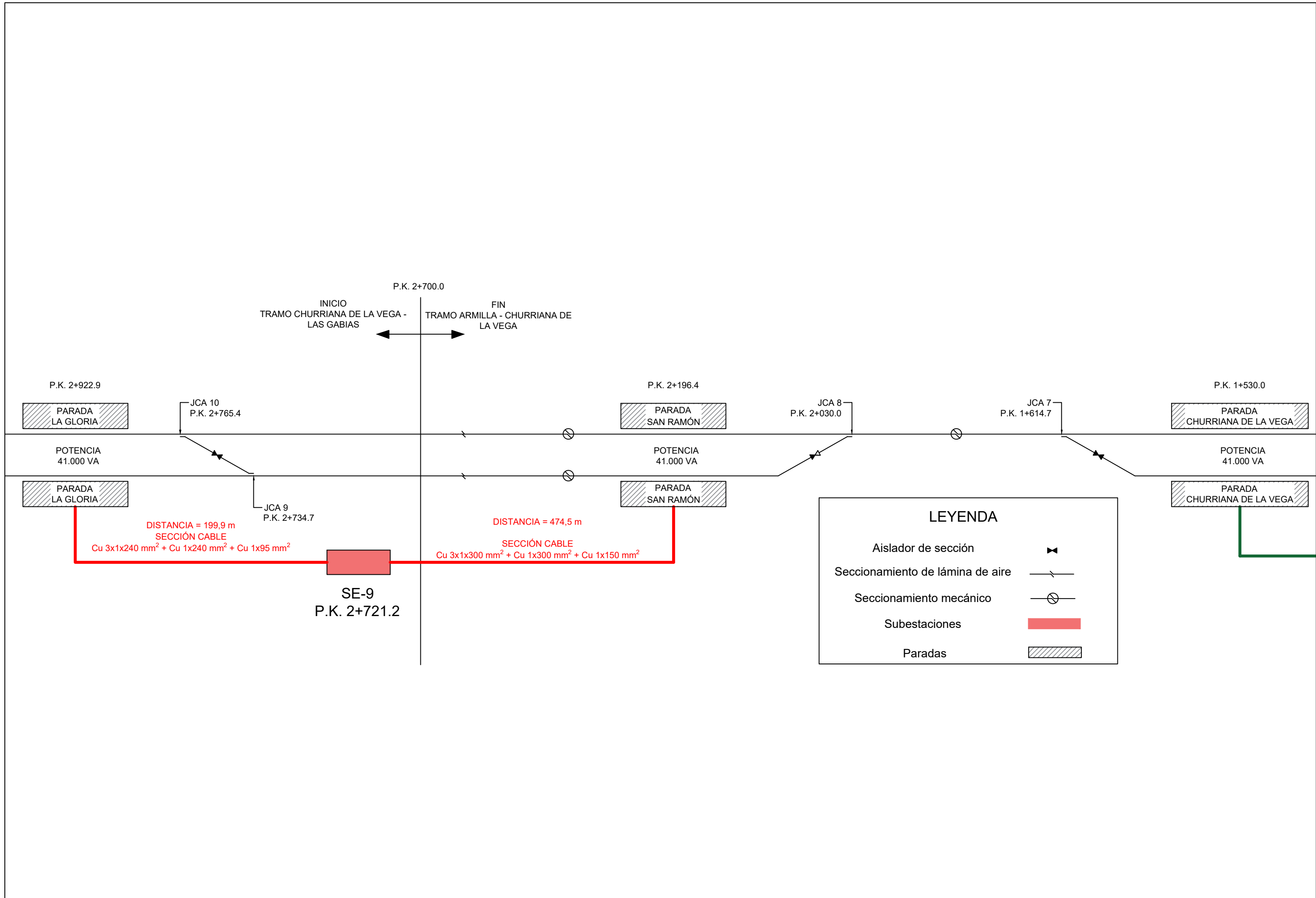

LEYENDA

Aislador de sección	
Seccionamiento de lámina de aire	
Seccionamiento mecánico	
Subestaciones	
Paradas	

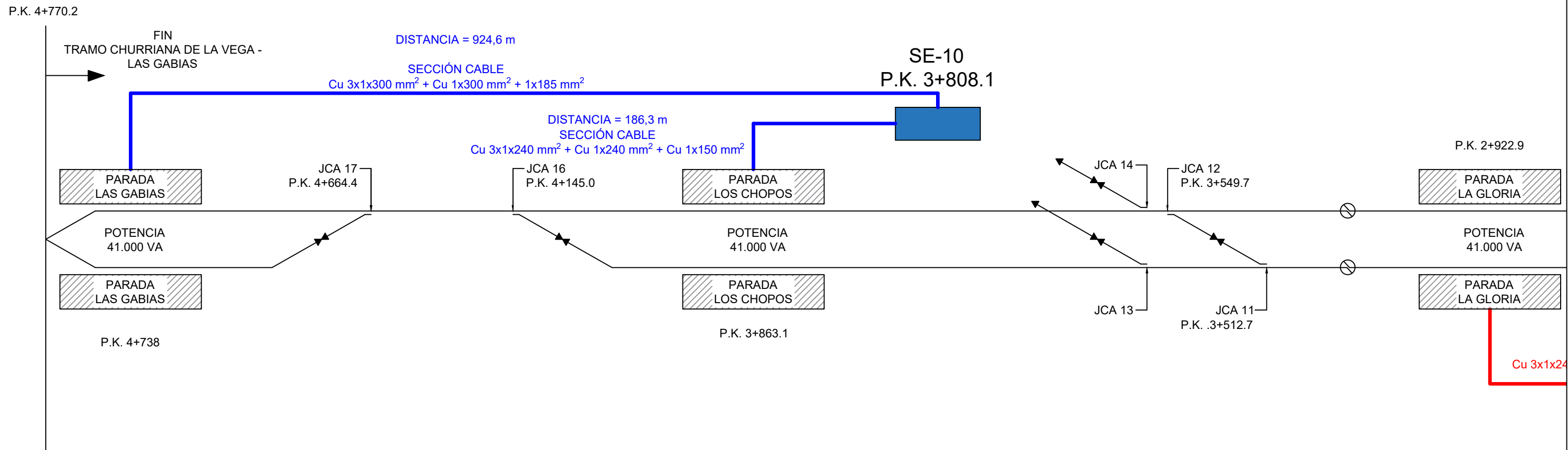

LEYENDA	
Aislador de sección	
Seccionamiento de lámina de aire	
Seccionamiento mecánico	
Subestaciones	
Paradas	